



# EOS-24V288W-5N1

288W 24V DIMMABLE CLASS 2 LED DRIVER  
Triac/1-10V/0-10V/10V PWM/Rx



## "5-IN-1" DIMMING DRIVER FEATURES :

- Support isolate interface dimming  
Triac/0-10V/1-10V/10V PWM/Rx dimming
- Full range input voltage 100-277VAC
- Soft dimming and flicker-free at any brightness
- Dimming range 100%-0.1, support multiple lights dimming
- High PF, high efficiency, low THD
- SELV and Class 2 design
- cULus certified
- Suitable for dry, damp and wet locations
- Nominal life up to 100,000 hours
- 5-year warranty



## APPLICABLE PRODUCTS:

Suitable for diverse constant voltage product applications, such as: LED strips, COB strips, Neon strips, Rigid strips, Linear lights, Panel lights, Spot lights, Down lights, etc.

## TYPICAL APPLICATIONS:

- LED indoor lighting
- LED office lighting
- LED commercial lighting

**DIMENSIONAL DRAWINGS:** 11.7" x 4.3" x 1.7"  
297.5 x 109 x 43mm

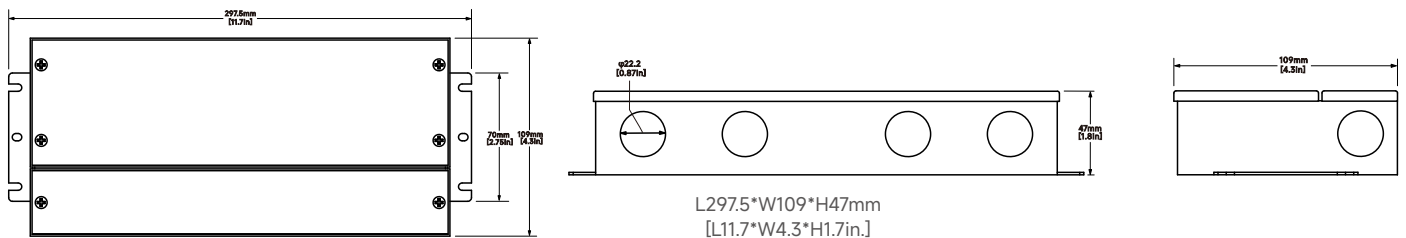



# EOS-24V288W-5N1 Technical Data



## Output Parameters

Regulation Method	Constant Voltage	Voltage Accuracy	±5%
Rated Output Voltage	24VDC	Linear Regulation	±3%
Rated Output Power	288W MAX	Load Regulation	±5%
Output Voltage Ripple LF	≤500mV(Vpp)	No Load Output Voltage	24V
Flicker-Free	Pst LM<1, SVM<0.4, Percent Flicker≤5%@≤200Hz (The above parameters are tested w/ constant voltage light strip)		

## Input Parameters

Rated Input Voltage Range	100-277VAC
Input Voltage Range	100-305VAC
Input Current	2.8A/100VAC, 1.4A/230VAC, 1.1A/277VAC
Input Frequency	47~63Hz
Input THD	<10%(@load≥50%/100VC; @load≥60%/230VAC; @load≥75%/277VAC)
In-Rush Current	90A peak, 260us duration(50 % Ipeak), @ 277VAC
Start/Switchover/Turn Off	<0.5s(100VAC)
Switching Cycles	>50,000 switching cycles

## Safety

Withstand Voltage	I/P-O/P(LED): 3750VAC, I/P-FG: 1750VAC, O/P-FG:500VAC, I/P-DIM: 1500VAC,O/P-DIM: 1500VAC.
Mains Surge Capability	L-N: 4KV, L-FG/N-FG: 6KV(Performance criterion: A)

## Control Interface

1-10V 4 in1 Dimming Port	Voltage Range: 0-20V, interface current consumption: <1mA
Dimming Range	0.1-100%

## Environment & Lifetime

Operating Temperature	Ta=-20-45°C
Storage Temp./Humidity	-40-80°C, 5-85% RH, not condensed
IP Grade	IP65
MTBF	500,000H,MIL-HDBK-217F(25°C)
Lifetime	Nominal lifetime up to 100,000 hours
Vibration Resistant	10~500Hz,5G 12min./1cycle,period for 72min. each along X,Y,Z axes
Acoustic Noise	<25dB(30cm, Normal Operation)
Environmental Protection	RoHS

## Certifications and Standards

Certification	UL8750
---------------	--------



# EOS-24V288W-5N1 Electrical Data



## Electrical Values

Efficiency vs Load

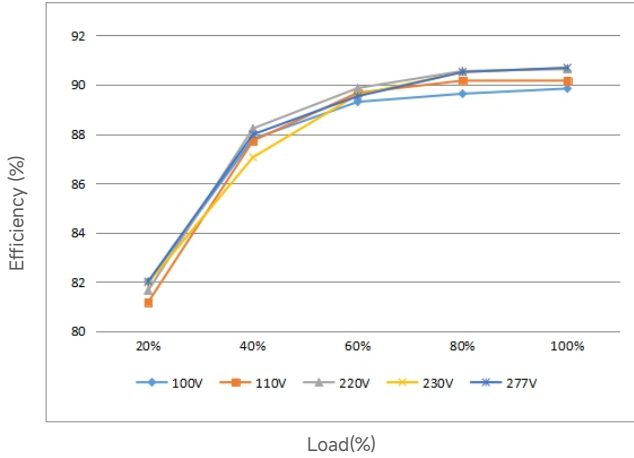

Power Factor vs Load

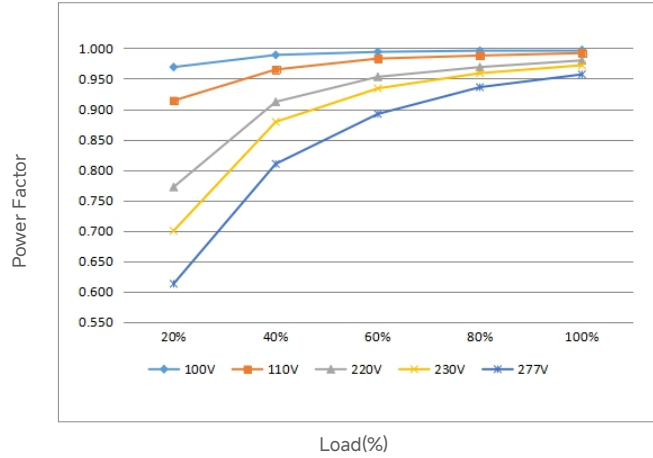

THD vs Load

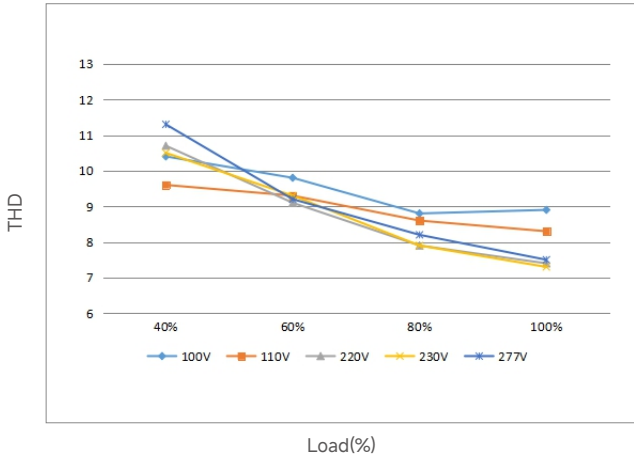

## Expected Lifetime

Lifetime vs Case Temperature

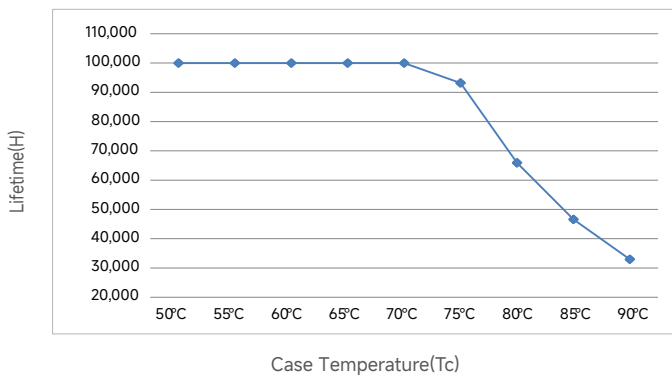

- The lifetime of the LED driver is shown in the figure (calculated based on the 90% survival rate).
- The relation between Tc and Ta temperature also depends on the luminaire design.



# EOS-24V288W-5N1 Wiring Diagram



## Non-Dimming Application Wiring Diagram (Single channel)

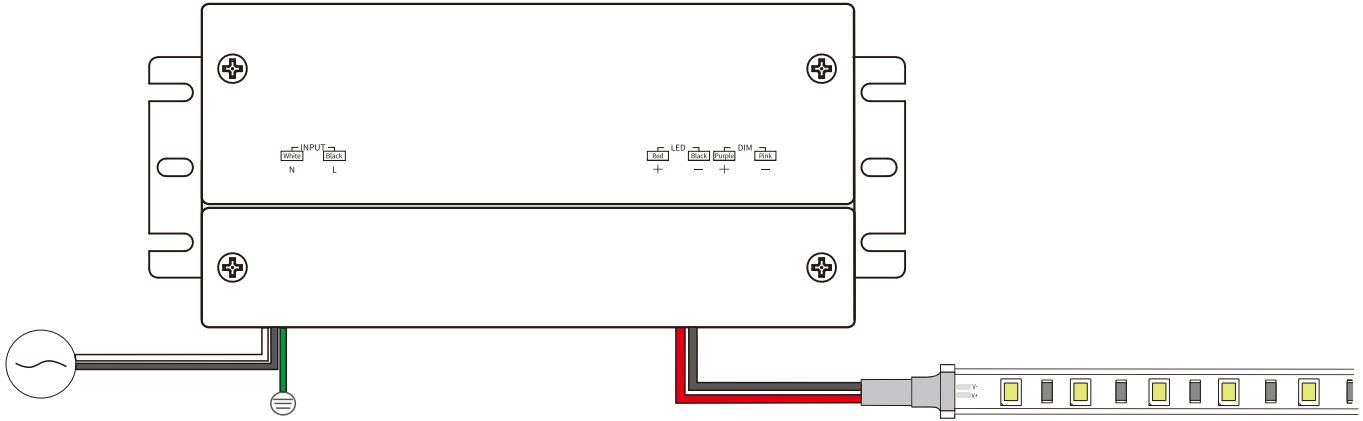

### Remarks

- It's recommended that the power consumption of load between 5%-100% range of the driver.
- This driver should be installed by qualified and professional person.
- Please make sure the driver is installed in ventilation environment for good heat dissipation.
- For avoiding driver damage, please make sure the electric wiring is correct before testing.
- It's recommended to test samples before placing order.



# EOS-24V288W-5N1 Wiring Diagram

Triac Dimming Application  
Wiring Diagram (Single channel)

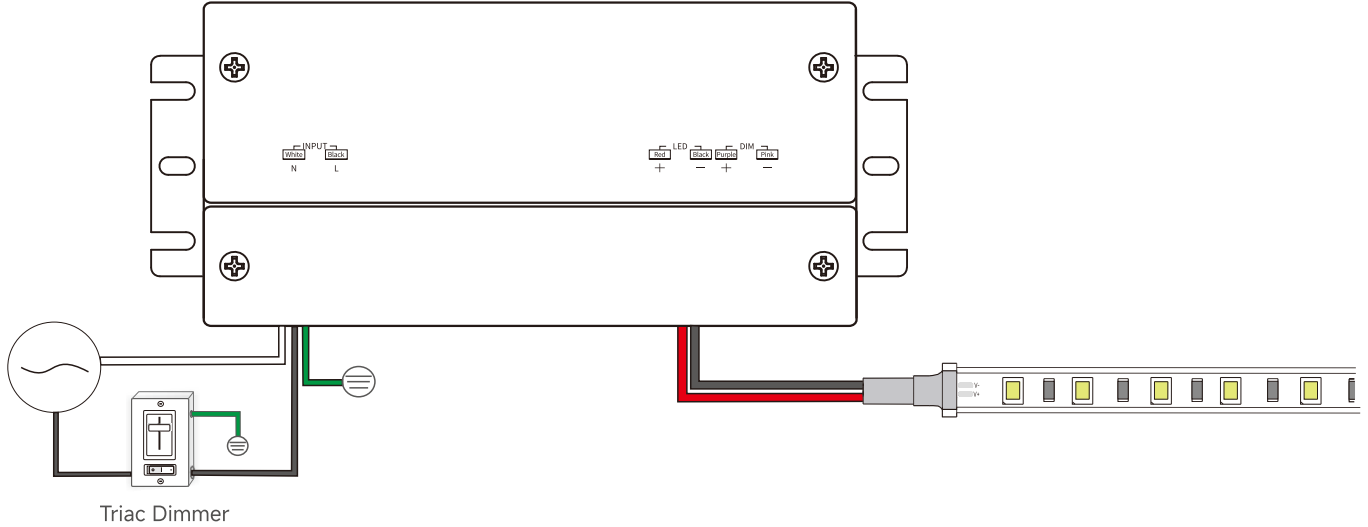

## Recommended Dimmer List

Brand	LUTRON						
Part No.	TGCL-153P	STCL-153M	SCL-153P	RCL-153PNL	DVCL-153P	DV-600P	IPL06
	MSCL-OP153M	MACL-153M	DVRF-6L	DVLV-600P	CTCL-153P	CTCL-150	DSL06

## Remarks

- It's recommended that the power consumption of load between 5%-100% range of the driver.
- This driver is compatible with both leading edge and trailing edge triac dimmer.
- This driver should be installed by qualified and professional person.
- Please make sure the driver is installed in ventilation environment for good heat dissipation.
- For avoiding driver damage, please make sure the electric wiring is correct before testing.
- It's recommended to test samples before placing order.

## Dimming Curve

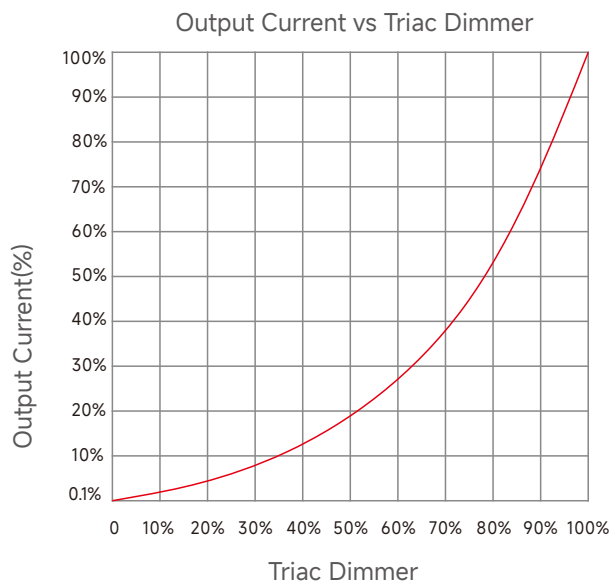

## 0-10V/1-10V/10V PWM/Potentiometer Dimming Application Wiring Diagram (Single channel)

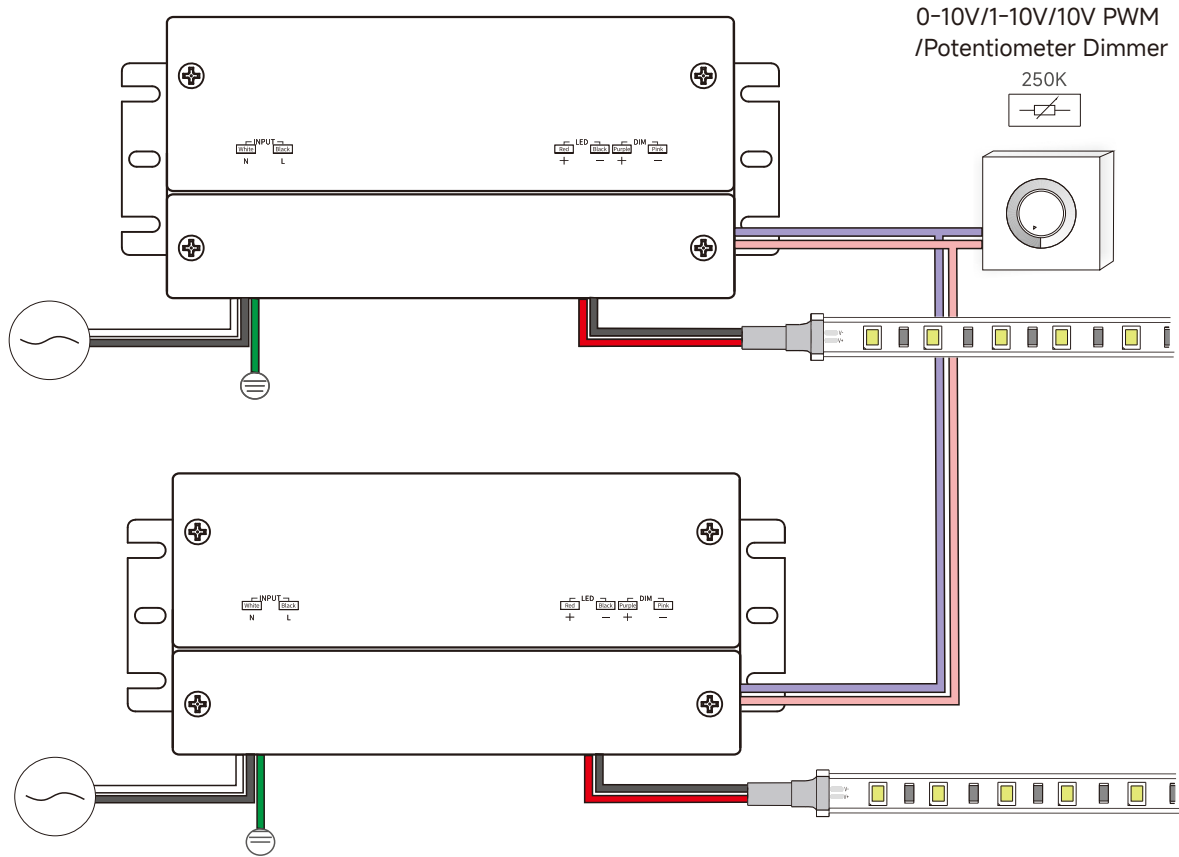

### Remarks

- Dimming interface characteristics: 0.9V and below are closed, 1V is the darkest, 10V is the brightest, 1-10V is the dimming range.
- The dimming interface distinguishes between positive and negative, DIM+ is positive, DIM- is negative, please do not reverse.
- Dimming interface does not support voltage access higher than 20V, otherwise it will cause damage to the internal components.
- When the dimming interface is open, the driver outputs the maximum current. When the interface is short-circuited, the current output is closed.
- When multiple synchronous dimming is required, the positive poles of the dimming interface of each driver are connected together, and the negative poles are connected together.
- Support passive dimmer or isolated active dimmer dimming, does not support non-isolated active dimmer dimming.
- In general, it is recommended that the number of mounted drives does not exceed 30pcs, and the wiring length does not exceed 100m.
- It is recommended that the dimming wires should not be lower than the 22AWG wire.
- Do not put the dimming wires with high voltage or interference sources. If it is unavoidable, please use the shielded wires.
- It is recommended to test samples before placing order.

### Dimming Curve

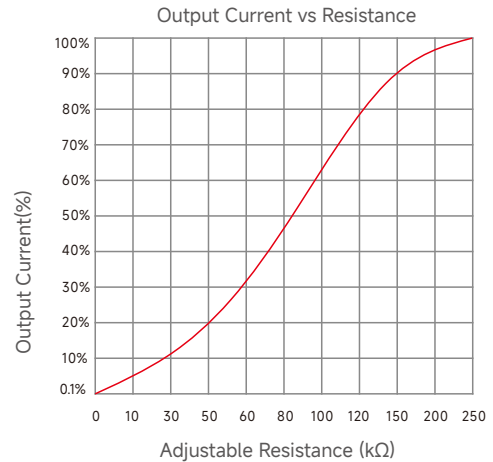
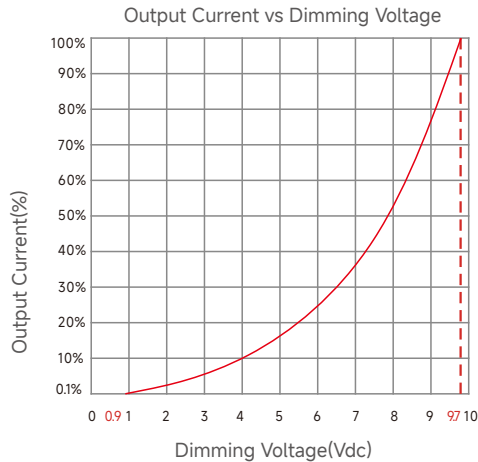



# EOS-24V288W-5N1 Wiring Diagram



## Non-Dimming Application

Wiring Diagram (3 channels)

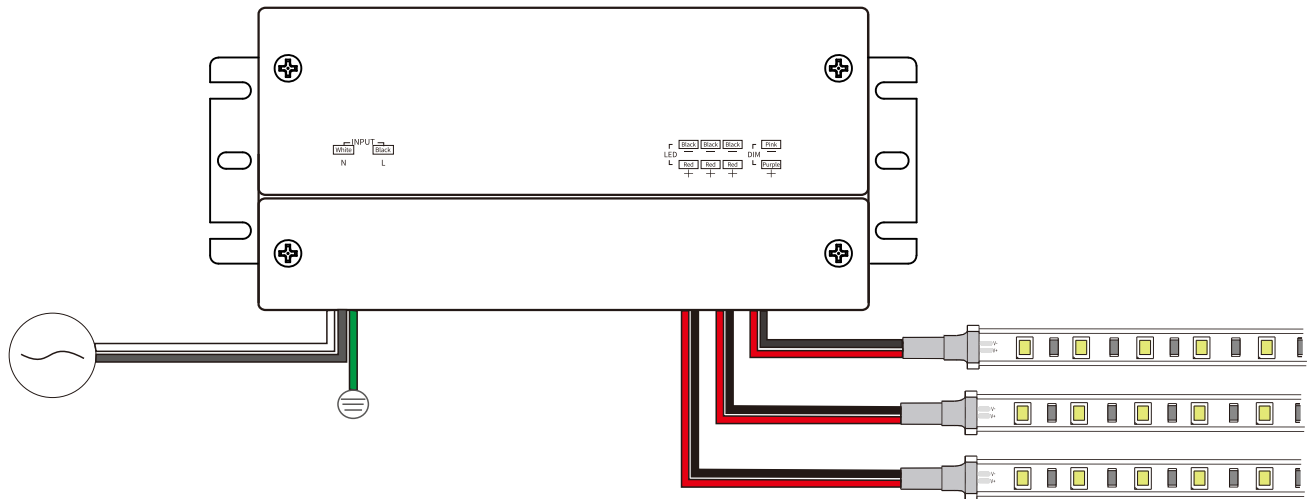

## Remarks

- It's recommended that the power consumption of load between 5%-100% range of the driver.
- This driver should be installed by qualified and professional person.
- Please make sure the driver is installed in ventilation environment for good heat dissipation.
- For avoiding driver damage, please make sure the electric wiring is correct before testing.
- It's recommended to test samples before placing order.



## Triac Dimming Application

Wiring Diagram (3 channels)

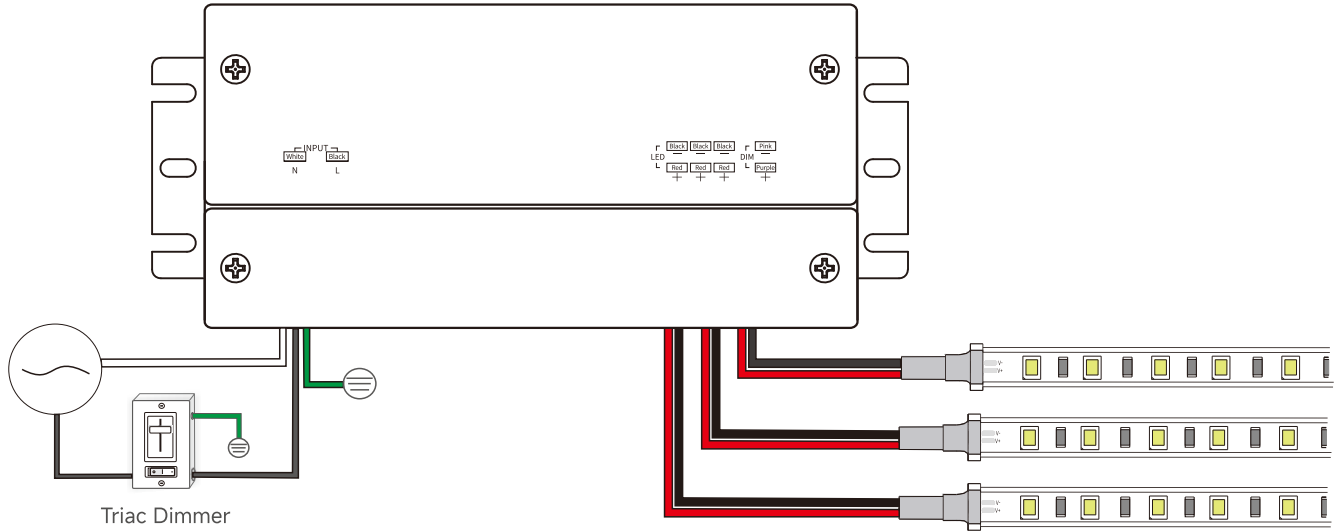

## Recommended Dimmer List

Brand	LUTRON						
Part No.	TGCL-153P	STCL-153M	SCL-153P	RCL-153PNL	DVCL-153P	DV-600P	IPL06
	MSCL-OP153M	MACL-153M	DVRF-6L	DVLV-600P	CTCL-153P	CTCL-150	DSL06

## Remarks

- It's recommended that the power consumption of load between 5%-100% range of the driver.
- This driver is compatible with both leading edge and trailing edge triac dimmer.
- This driver should be installed by qualified and professional person.
- Please make sure the driver is installed in ventilation environment for good heat dissipation.
- For avoiding driver damage, please make sure the electric wiring is correct before testing.
- It's recommended to test samples before placing order.

## Dimming Curve

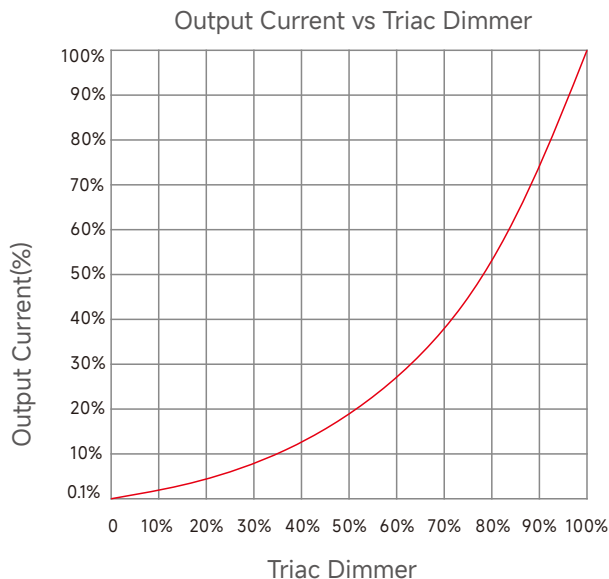



## 0-10V/1-10V/10V PWM/Potentiometer Dimming Application

Wiring Diagram (3 channels)

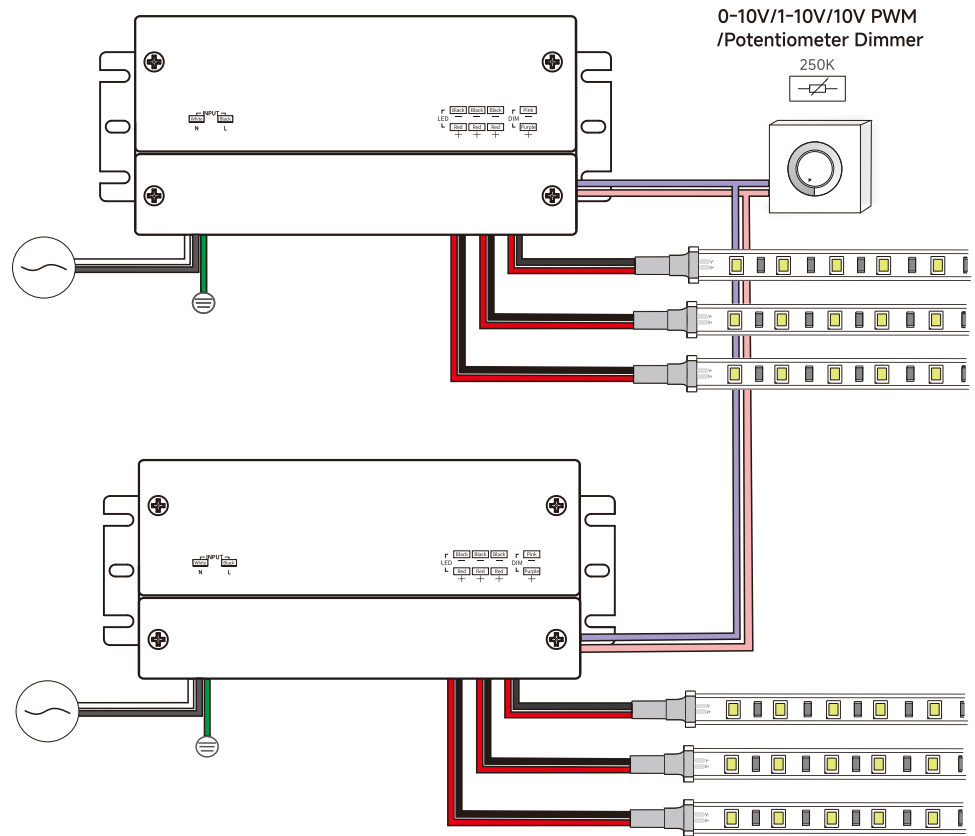

### Remarks

- Dimming interface characteristics: 0.9V and below are closed, 1V is the darkest, 10V is the brightest, 1-10V is the dimming range.
- The dimming interface distinguishes between positive and negative, DIM+ is positive, DIM- is negative, please do not reverse.
- Dimming interface does not support voltage access higher than 20V, otherwise it will cause damage to the internal components.
- When the dimming interface is open, the driver outputs the maximum current. When the interface is short-circuited, the current output is closed.
- When multiple synchronous dimming is required, the positive poles of the dimming interface of each driver are connected together, and the negative poles are connected together.
- Support passive dimmer or isolated active dimmer dimming, does not support non-isolated active dimmer dimming.
- In general, it is recommended that the number of mounted drives does not exceed 30pcs, and the wiring length does not exceed 100m.
- It is recommended that the dimming wires should not be lower than the 22AWG wire.
- Do not put the dimming wires with high voltage or interference sources. If it is unavoidable, please use the shielded wires.
- It is recommended to test samples before placing order.

### Dimming Curve

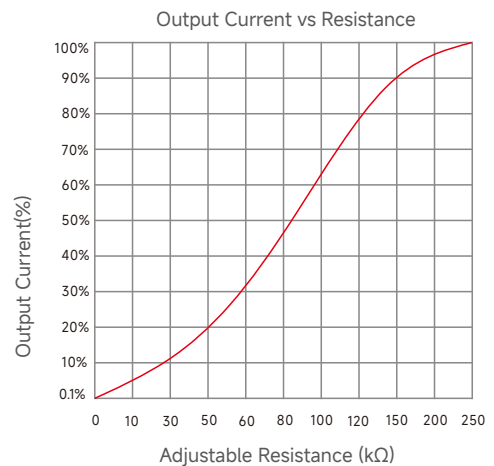
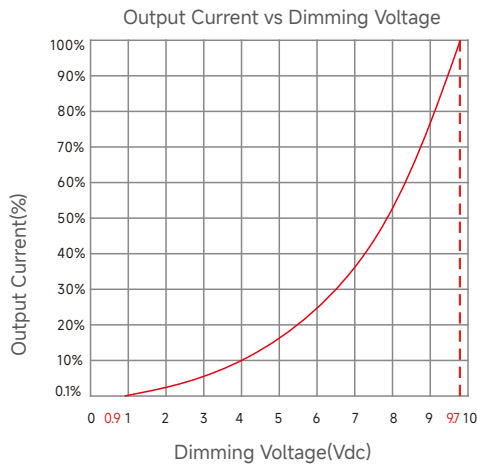



# EOS-24V288W-5N1 Installation



## Installation Notice

1. This product can only be used outside the light body, can not be used inside of the light, and it must be used within the specified working environment.
2. The lifetime and MTBF of the product are for reference only, and do not represent a warranty statement.
3. The driver should be installed in a dry, acid-free, oil-free, fat-free environment.
4. The installation ambient temperature of the drive shall not exceed the value of  $T_a$  at any time.
5. The driver should keep a certain distance from the heating stuff(such as the lamp radiator).
6. Hot plug-in is not supported due to residual output voltage of  $> 0$  V.
7. All connections must be kept as short as possible to ensure good EMI behaviour.
8. Mains leads should be kept apart from LED Driver and other leads(ideally 5 - 10 cm distance).
9. Max. length of output wires is 2 m.
10. Incorrect wiring can damage LED modules.
11. Connect Drivers Directly to LEDs. The output of an LED driver is specifically calibrated for LED lights and must be wired directly to them. Never connect the output of one driver to the input of another; this creates an unsafe electrical setup that can damage both drivers, cause lights to fail, and pose a fire hazard.
12. Enclose Outdoor Drivers. Even though the driver is rated IP65 (dust-tight and protected from rain), it must be placed inside a protective enclosure, like a junction box, for any outdoor installation. The primary risk is not to the driver's sealed case but to its wiring connections. An enclosure shields these vulnerable connections from moisture, preventing short circuits, corrosion, and electrical hazards, ensuring the system remains safe and durable.